

CAPITAL MARKETS DAY 2025



**SOLIDWORKS
MAINSTREAM
BUSINESS BRIEF
FOR CMD
| JUNE 2025**

SOLIDWORKS 30TH ANNIVERSARY

8,000,000 USERS

1,400,000+ COMMERCIAL SEATS

285,000+ COMMERCIAL CLIENTS

450 CUSTOMER ROLE EXPERIENCE
PARTNERS IN 120 COUNTRIES

CAD MARKET LEADERSHIP & GLOBAL INDUSTRY FOOTPRINT

44%

New commercial
CAD Seat WW
share (2024)

3D SOLIDWORKS

€1.1Bn+

2024 REVENUE

31%

Industrial
Equipment

19%

Medical Devices

13%

Hi Tech

Of SOLIDWORKS Mainstream Revenues

7%

AEC

6%

Infrastructure,
Energy &
Materials

3%

Home &
Lifestyle

UNLOCKING GROWTH IN A \$20Bn MARKET

Mainstream Revenue

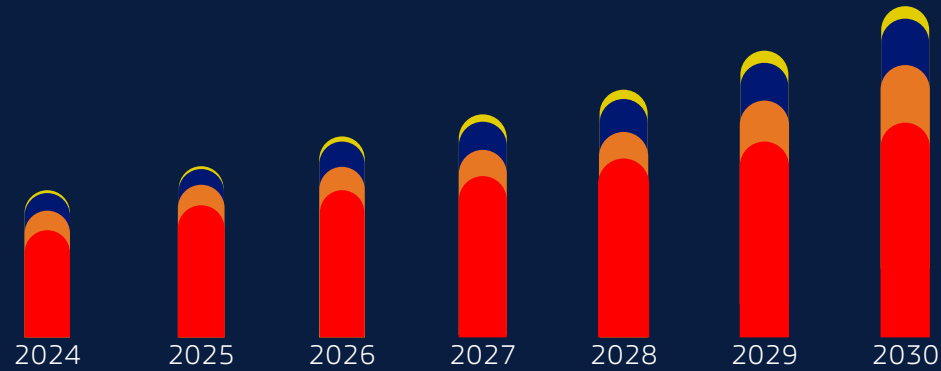

DESIGN
\$8Bn

SIMULATION
\$5Bn

PLM
\$5Bn

MFG
\$2Bn

GROWTH DRIVERS

THE POWER
OF THE
COMMUNITY



THE POWER
OF THE
PLATFORM



3D UNIV+RSES
THE POWER
OF **INNOVATION**



THE POWER
OF THE
ECOSYSTEM





GROWTH DRIVERS

THE POWER OF THE COMMUNITY



2,200,000
SOCIAL
MEDIA FANS



33,500
ACADEMIC
INSTITUTIONS



800
FAB LABS

95,000
MAKERS



25,000
STARTUPS

475
INCUBATORS
& ACCELERATORS





2018

PROTOTYPING BEGINS

endiatx

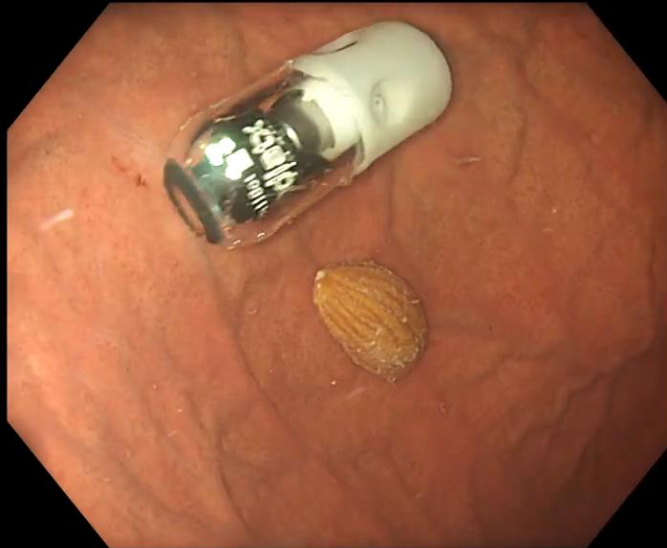
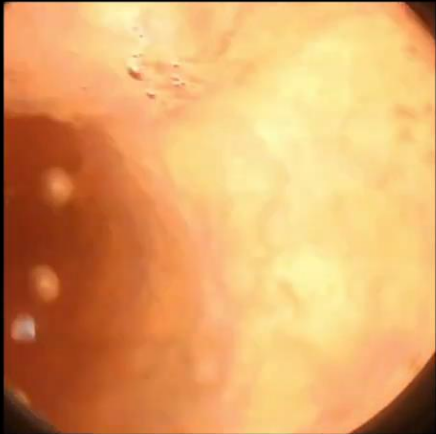

here's to the future of telemedicine





GROWTH DRIVERS

THE POWER OF THE PLATFORM

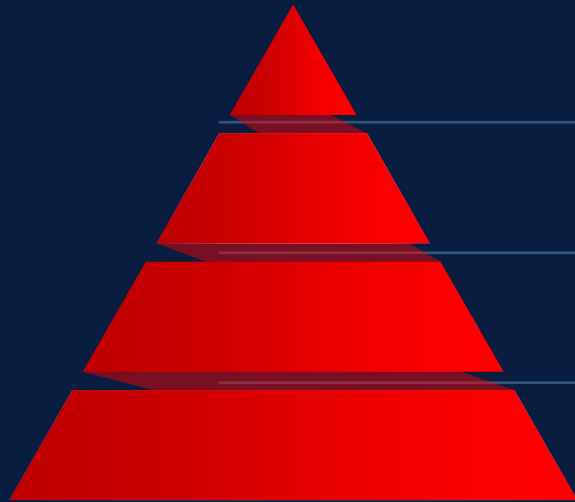

SOLIDWORKS
ULTIMATE

SIMULATION
MULTIPHYSICS

PLM
PRO

SOLIDWORKS
PREMIUM

SIMULATION
ANALYST

PLM
STD

MILLING & TURNING
PREMIUM

SOLIDWORKS
PROFESSIONAL

SIMULATION
ENGINEER

TURNING
PROFESSIONAL

SOLIDWORKS
STANDARD

SIMULATION
DESIGNER

MILLING
PROFESSIONAL

MAINSTREAM
Value Offers

**MOD
SIM**

**ADVANCED
SIMULATION**

**MID MARKET
PLM**

**DIGITAL
MANUFACTURING &
FACTORY
AUTOMATION**

MAGLEV AERO

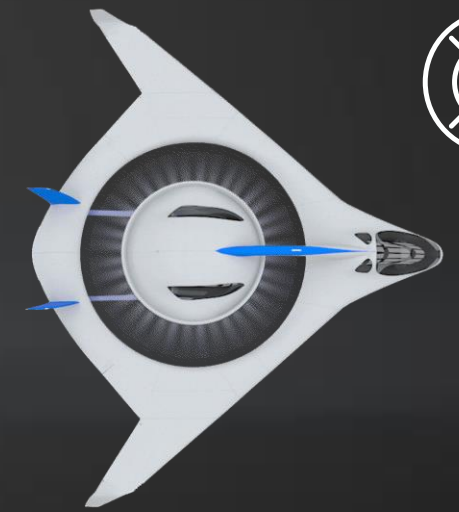

Unlocking a clean and quiet solution for
the Urban Air Mobility mass market



Unducted Rotor

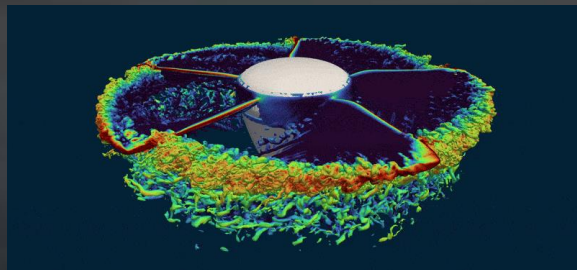

Ducted Rotor

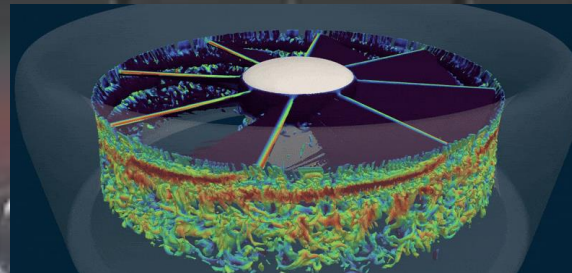

Ducted MagLev HyperDrive™

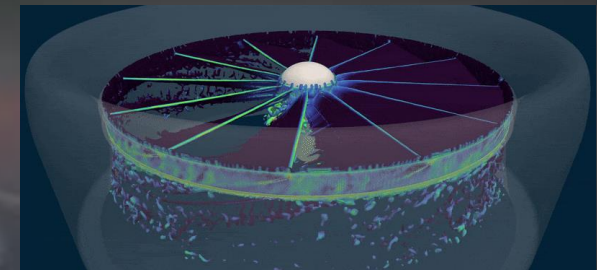

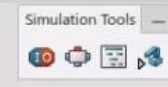



LYNRED INFRARED DETECTORS
BRING YOUR THERMAL CAMERAS TO LIFE



GROWTH DRIVERS

3D UNIVERSES THE POWER OF INNOVATION

GENERATIVE AI IN THE CLOUD



Generative
Drawings



AI Assembly
Companion



Command
Predictor



Natural Language
Integration



Assembly Layout Sketch Markup Evaluate SOLIDWORKS Add-Ins Command Predictor (Beta)

- PM009492 (Base Main Shaft) <Default>
- History
- Sensors
- Annotations
 - Front
 - Top
 - Right
 - Origin
- PM009495<1> (PM009495) <<Def
- PM009494<1> (PM009494) <<Def
- (-) PM009493<1> ->x (PM009493)
- Mates

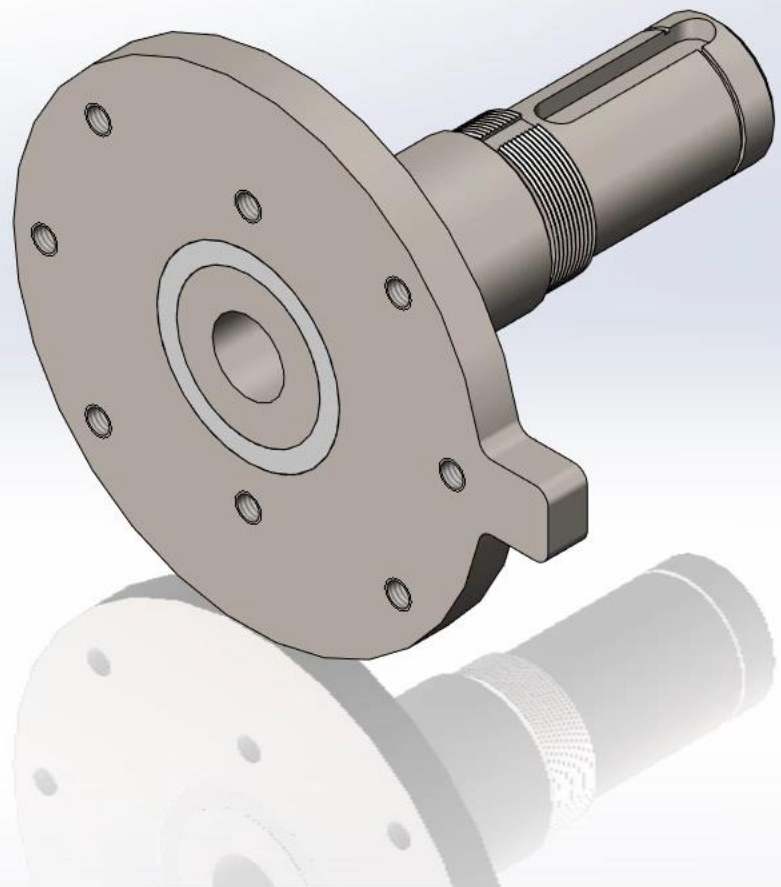

*Isometric



GROWTH DRIVERS THE POWER OF THE ECOSYSTEM

450 CUSTOMER ROLE EXPERIENCE PARTNERS

TRANSFORMING
THE LEGACY

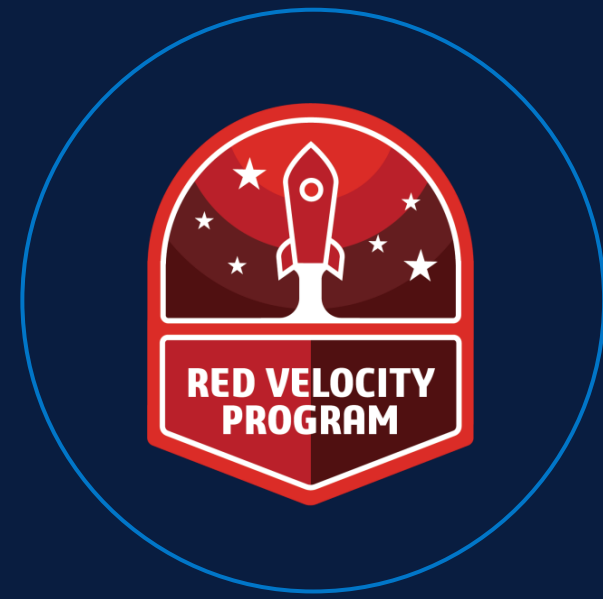

CREATING
A NEW LINEAGE
– THE RED
VELOCITY
PROGRAM



STEPHEN & ANNA WIERENGA THE POWER OF THE ENTREPRENEURS

CORE VALUES



PASSIONATE



DO WHAT IS RIGHT



HUMBLY CONFIDENT



STRIVE FOR EXCELLENCE



SOLIDWORKS





Buy SOLIDWORKS Online

Flexible Access



3DEXPERIENCE SOLIDWORKS

Proven, user-friendly, industry-standard 3D CAD and cloud collaboration with the benefits of named user licensing, including lower IT overhead and increased

Most Popular



SOLIDWORKS with Cloud Services

Proven, user-friendly, industry-standard 3D CAD and cloud collaboration, preferred by leading design and engineering professionals around the world.

Browser Based



SOLIDWORKS Cloud Offer

Next-generation, browser-based 3D CAD and collaboration from the team that brought you SOLIDWORKS.

NAM #1 PARTNER TOTAL BOOKINGS TARGET ATTAINMENT

SWYFT SOLUTIONS LLC







GROWTH DRIVERS

THE POWER
OF THE
COMMUNITY



THE POWER
OF THE
PLATFORM



3D UNIV+RSES
THE POWER
OF **INNOVATION**



THE POWER
OF THE
ECOSYSTEM



Accelerating **Growth**

