



**CAPITAL
MARKETS DAY**
2022

THE MOBILITY REVOLUTION

RIVIAN

Keep the World
Adventurous Forever

Barry Caldwell

Director,
Geometric Development & Operations



RIVIAN – THE COMPANY



FOREVER STARTS NOW

We hope our products inspire not just our customers to explore and protect the world, but other businesses to build and develop a whole different set of products to compete with ours.

RJ Scaringe
Founder and CEO



KEEPING THE WORLD ADVENTUROUS FOREVER

RIVIAN

US-based electric vehicle manufacturer founded in 2009

12,000 employees nationwide including 4,300 at our first manufacturing center in Normal, IL

Additional footprints in Michigan, California, and Vancouver, with staff in Europe and China

Initial Public Offering in November 2021 (RIVN)

3 vehicle lines currently in production, including the first all-electric pickup

Pre-IPO, backed by respected institutional and corporate investors including Amazon, Ford, T.Rowe Price, Coatue, and others

Building nationwide networks of retail locations, service centers, and charging stations





OUR EARTH

WHY ELECTRIC VEHICLES?

GLOBAL ENERGY STATISTICS

Global CO₂ Emissions

- 36.4 billion metric tons (2021)
- Transportation: 37% of emissions

Global Oil Demand

- 96 million barrels/day (2021)

United States Petroleum Demand

- 18 million barrels/day (2021)

Global Vehicle Fleet

- 1.31 billion (2021)
- 2.21 billion (2050 projection)
- > 20% of all road vehicles must be electric by 2030 to meet Paris Climate Agreement

2020 GLOBAL ELECTRIC VEHICLE MARKET STATISTICS (BNEF)

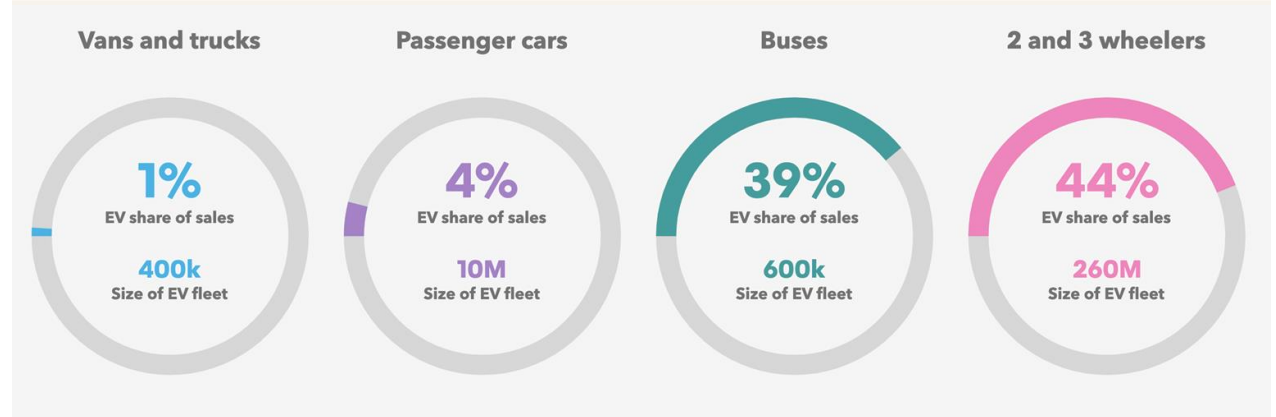

ELECTRIC VEHICLES BY REGION (IEA)

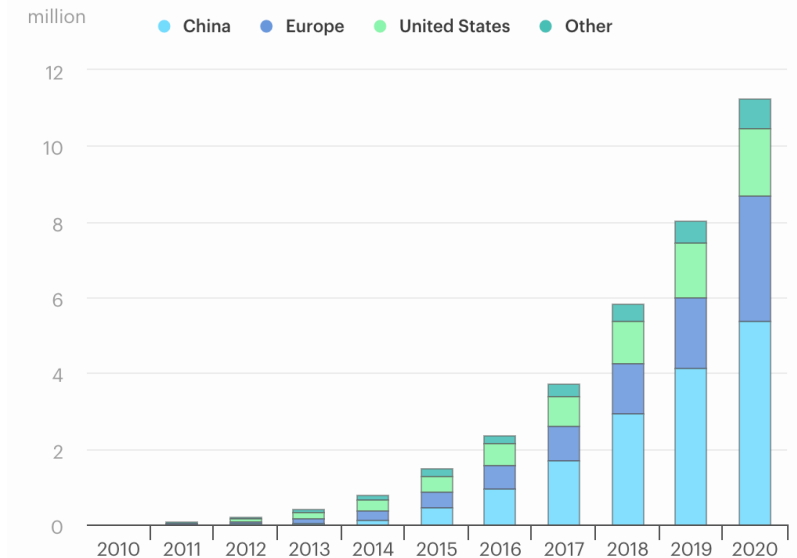

A close-up, over-the-shoulder view of a person's hands on a black steering wheel. The person is wearing a light blue long-sleeved shirt. The car's interior is dimly lit, with a prominent green ambient light strip visible behind the steering wheel. The background shows the car's dashboard and side mirror.

PRODUCT DEVELOPMENT

THE RIVIAN PLATFORM

Battery pack capable
of 314 miles of range

Quad-motor drive

Independent air
suspension and
hydraulic roll control

Durable skateboard
body architecture

Up to 34-inch
(864 mm) tires

Lightweight
multi-material body

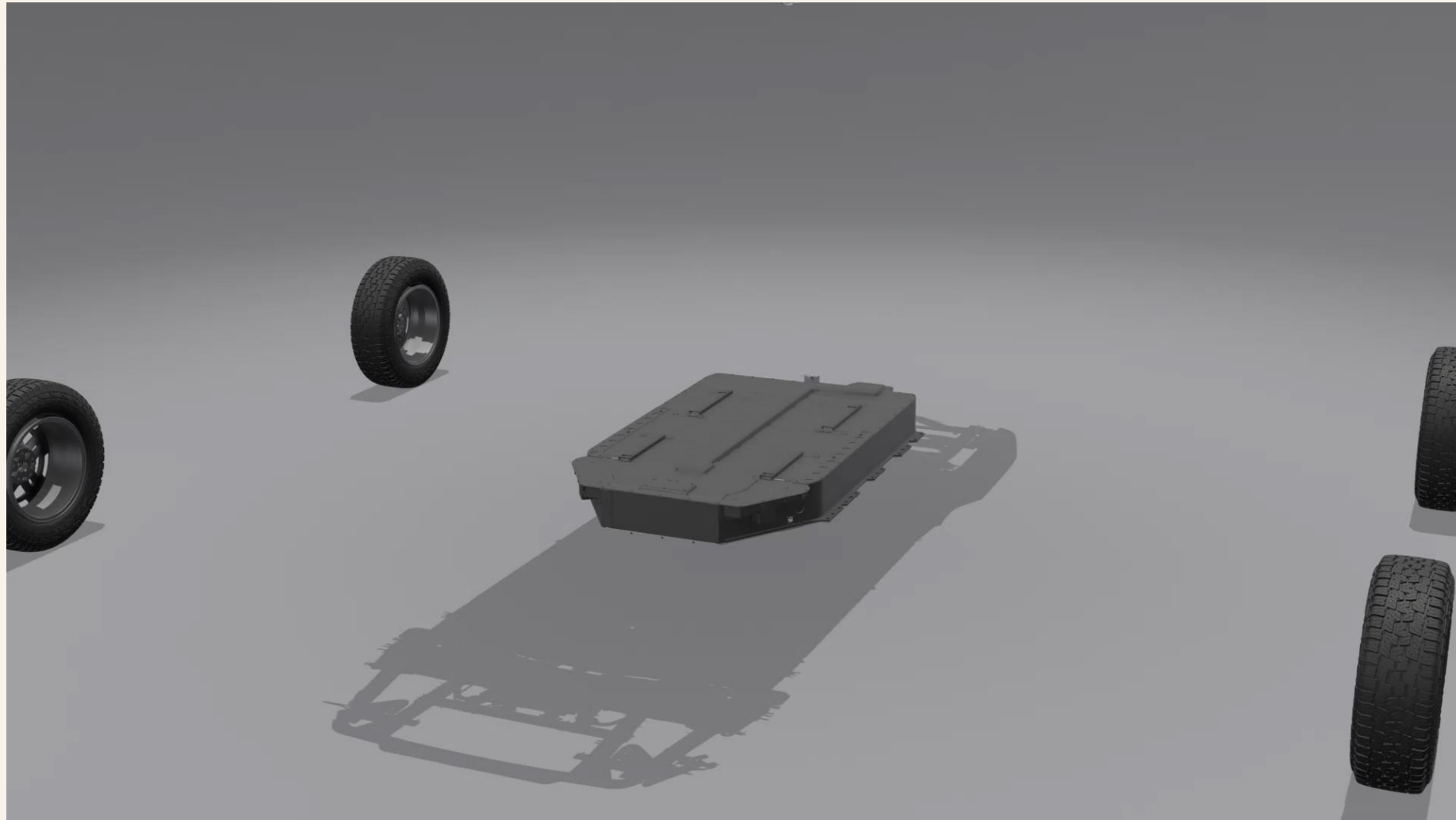

SAFETY PERFORMANCE

Body structure and battery frame designed to provide protection to the battery system during shallow offset.

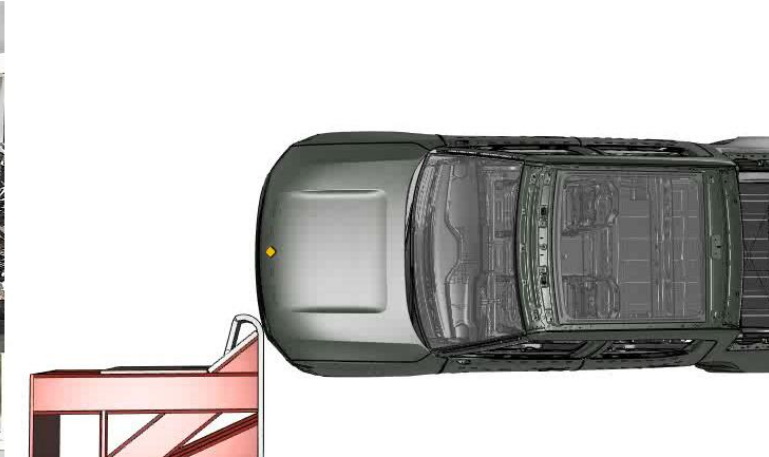
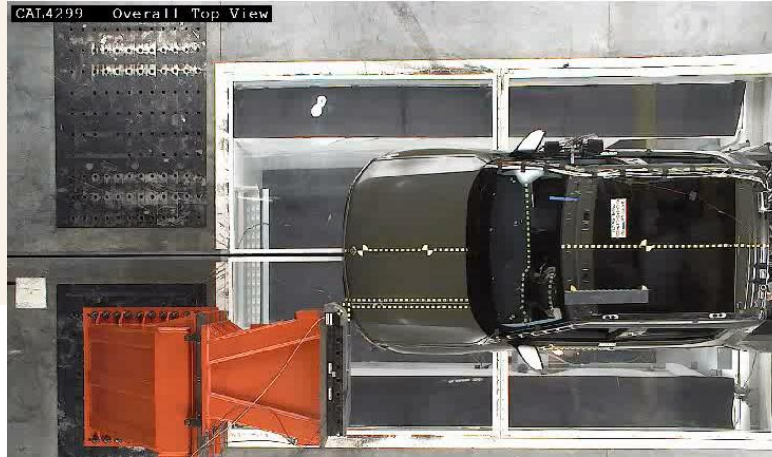



MANUFACTURING



NORMAL PRODUCTION FACILITY

4,000,000 Sq Ft Facility

Setting **4800 tons** (58 space shuttles) of core and shell steel and **3300 tons** (40 space shuttles) of paint mezzanine steel

Placed **38,000 cu. Yd.** (567 swimming pools) of concrete

Installing **1 mile of new electrical busway** and ...

10 miles
of 15kV cable

11 miles
of 600V cable

Installing
34 miles of
conduit and pipe
in the Paint Shop

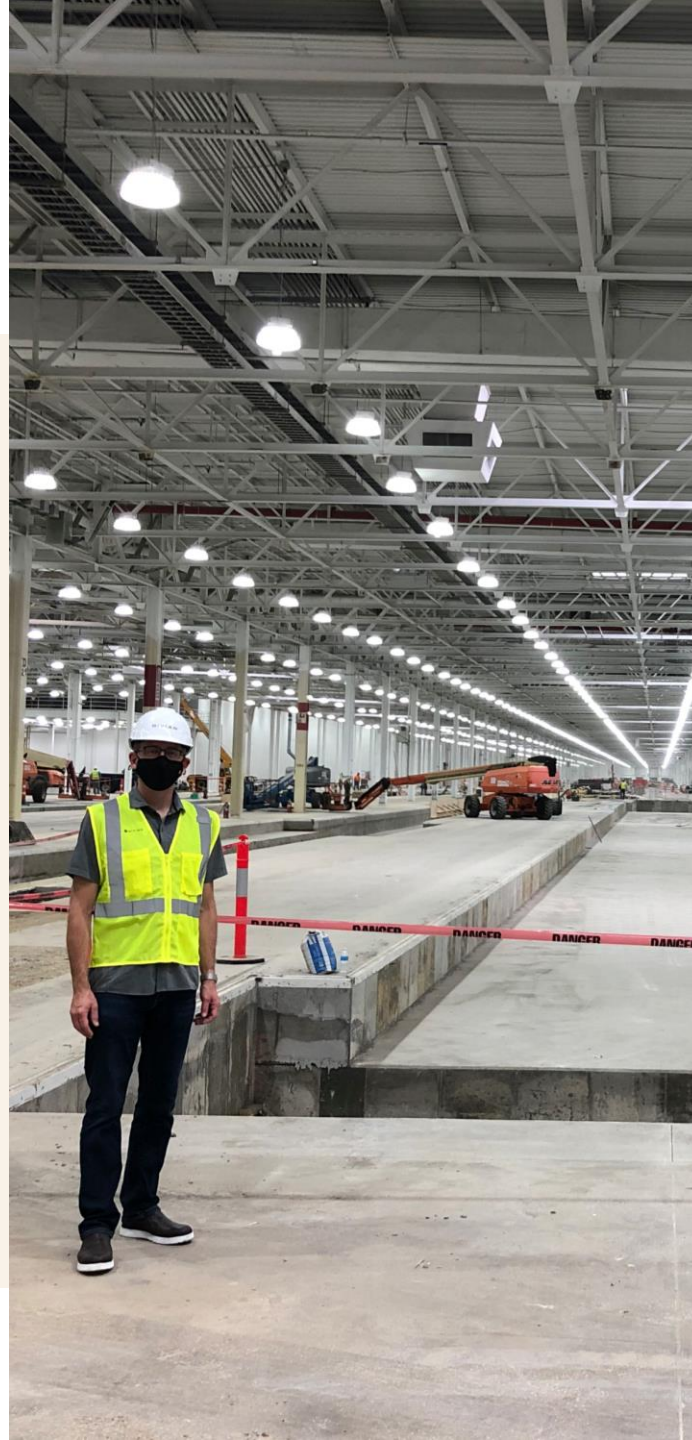

VIRTUAL PLANT



WHY THE 3DEXPERIENCE PLATFORM



KEY PERFORMANCE INDICES

TIME TO MARKET

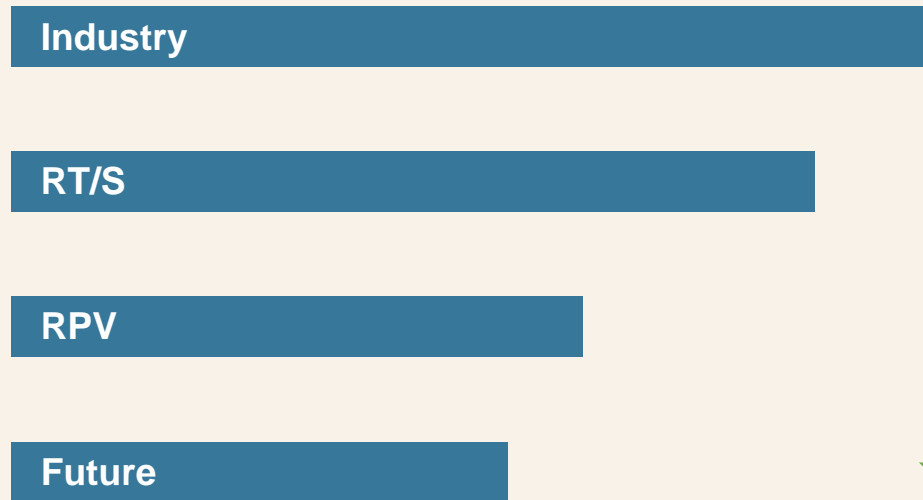

POST RELEASE CHANGES

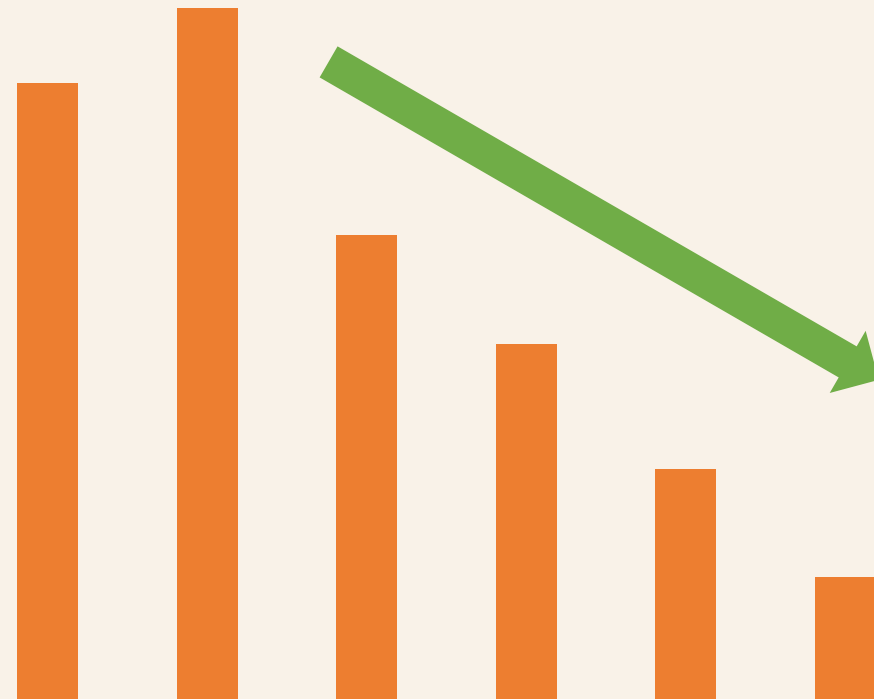

APPLICATION DOMAINS

PRODUCT DEFINITION



PRODUCT VERIFICATION

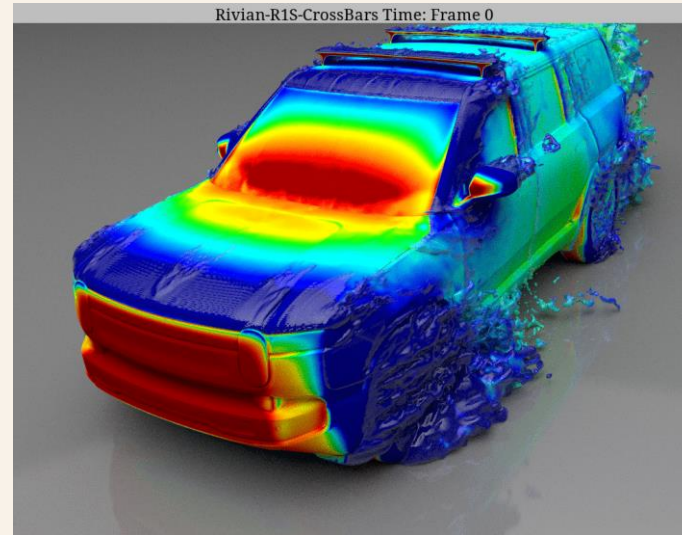

PROCESS DEFINITION

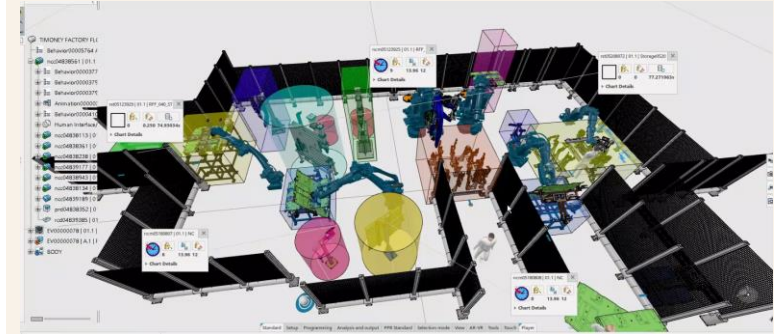

3DEXPERIENCE Platform

LEVERAGING THE 3DEXPERIENCE PLATFORM

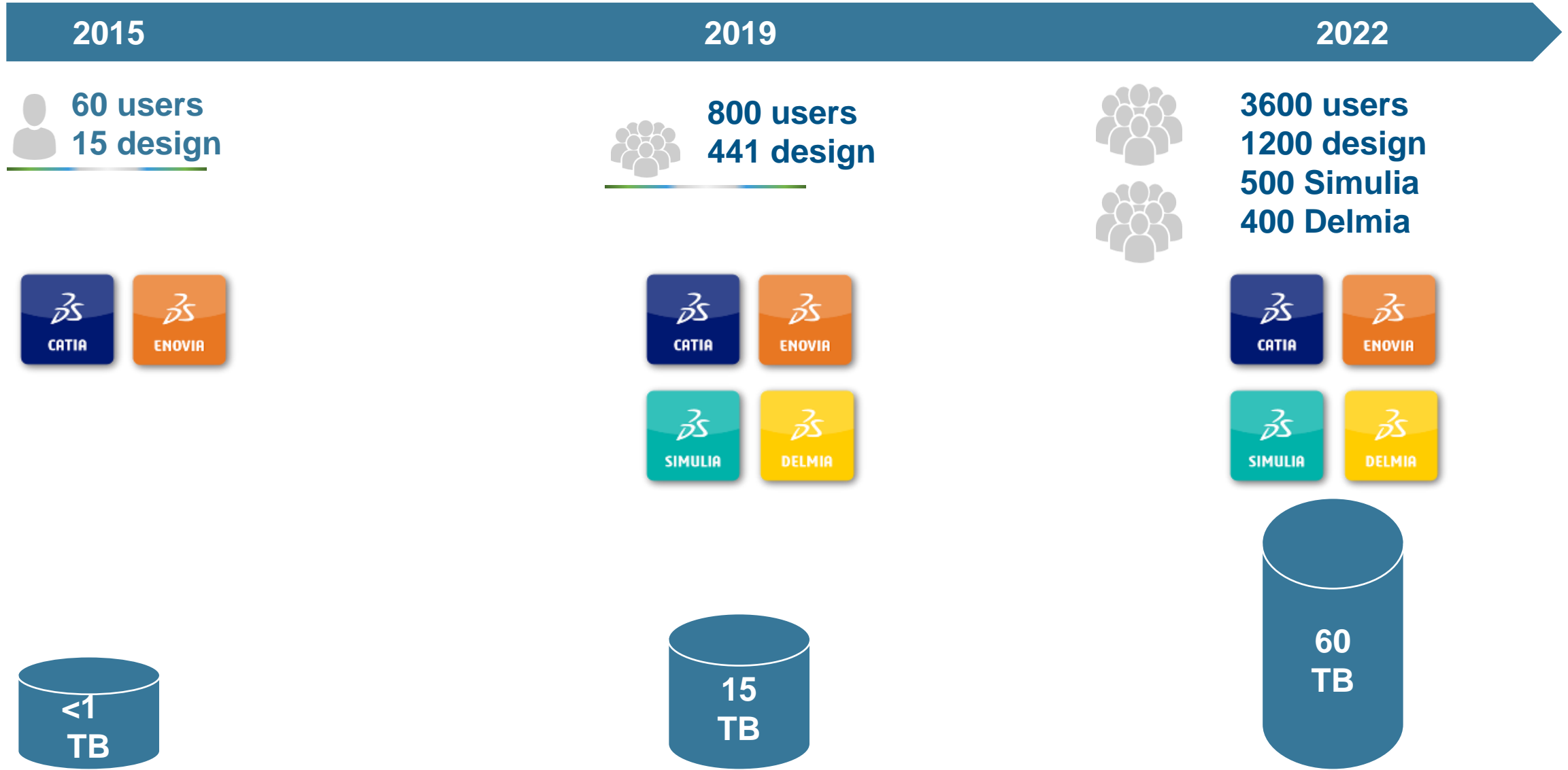

LOOKING FORWARD – EXPANDING THE PLATFORM'S USAGE

BIG DATA

More than 30,000 instance objects in a vehicle program in a Single Source of Truth - the **3DEXPERIENCE** Platform

SUPPLIER INTEGRATION

Interface with hundreds of supplier partners across the globe

ENTERPRISE COLLABORATION

Multiple application domains

INFORMATION INTELLIGENCE

Data mining, B2B, B2C

